

## VESILUKKOPUTKET PAINEMITTAREILLE DIN 16 282 SAPARO-MALLIN VESILUKKOPUTKET

### MALLI C

R ½" ulkokierre prosessiin

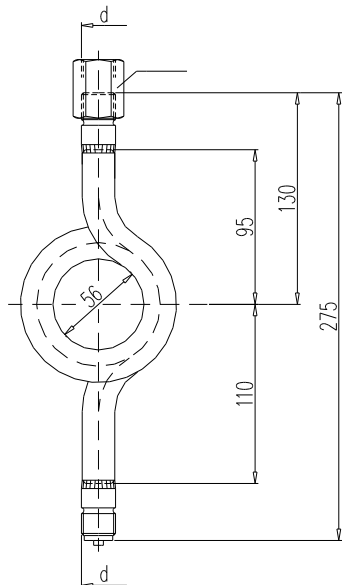



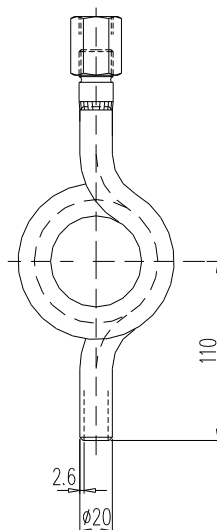

### MALLI D

hitsattava prosessiin



← kiristysmuhvi  
DIN 16283

Malli A	S006.08.100	S006.08.200	Malli B	S006.08.110	S006.08.210
					
Kierre	R ½" x R ½"	R ½" x R ½"	Kierre	R ½" x hits.	R ½" x hits.
Materiaali	Teräs St 35.8	1,4571 (hst)	Materiaali	Teräs St 35.8	1,4571 (hst)

### Lämpötila/painetaulukko:

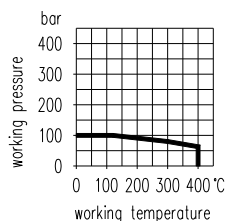

LVI-NUMERO	MALLI:
<b>4582085</b>	S006.08.100
<b>4582090</b>	S006.08.200